

I. Introduction

Second-order circuits are circuits that can be represented by a second-order differential equation. A second-order circuit will contain a total of two energy storage elements, inductors and/or capacitors. We can theoretically derive the roots of the differential equation through calculation. However, we can also better understand the roots by experimentally measuring the circuit step response and frequency response. We can also see how the resistance affects the circuit's behavior by testing the response generated by circuits with the same inductance and capacitance but different resistances. In order to mitigate interference from the MyDAQ device used to supply input and measure output, an op-amp will be used as a buffer. This buffer circuit must be tested as well to ensure its functionality.

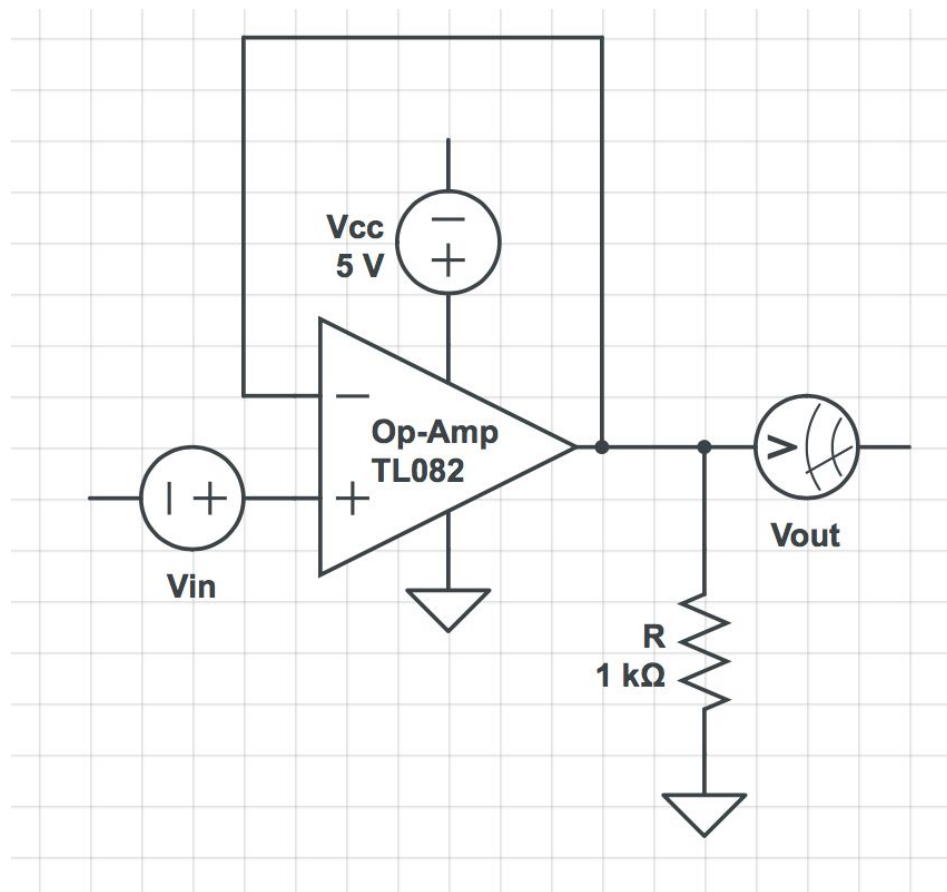

Figure 1. Circuit used to test op-amp buffer

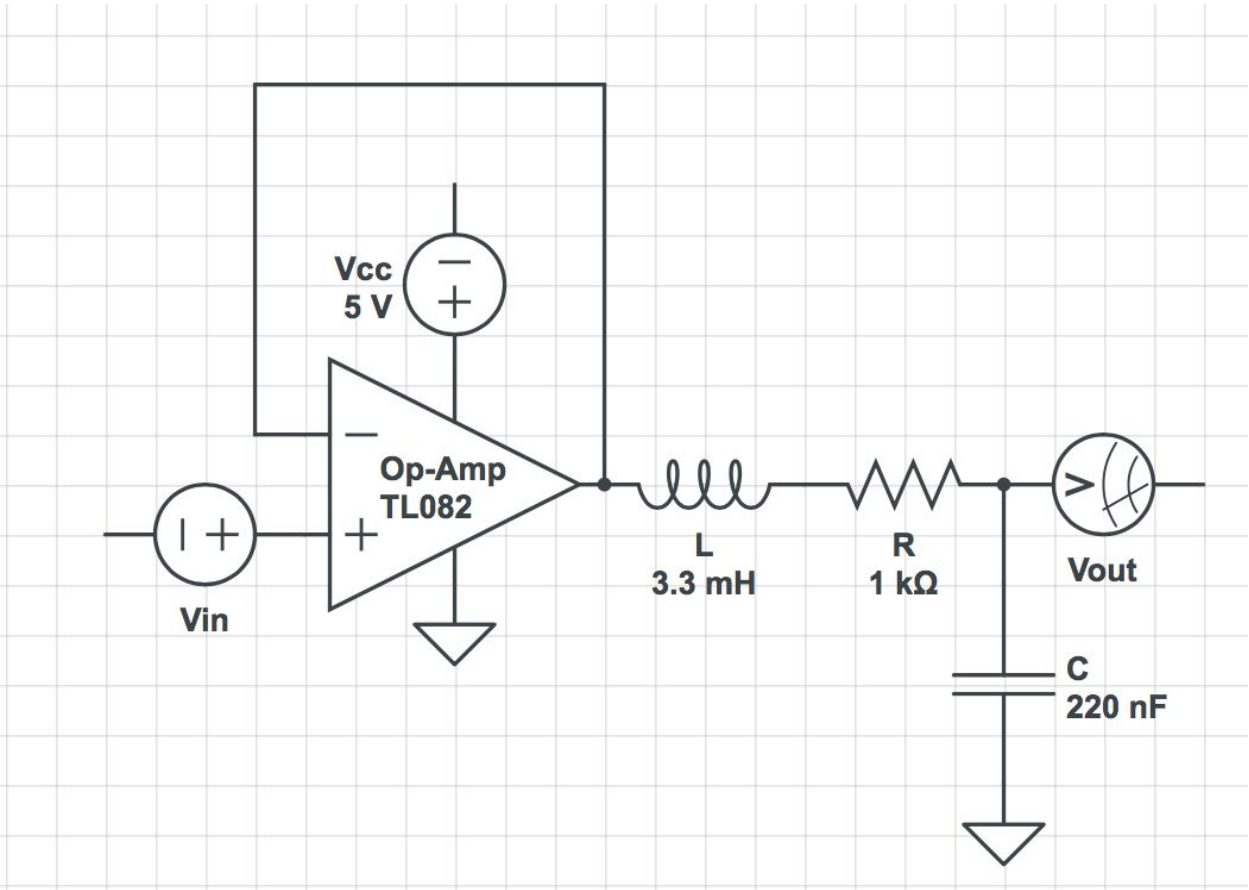

Figure 2. Second-Order circuit used to experimentally measure response. Resistance value R will be varied in subsequent tests.

II. Data Analysis

A. Op-Amp Test Circuit

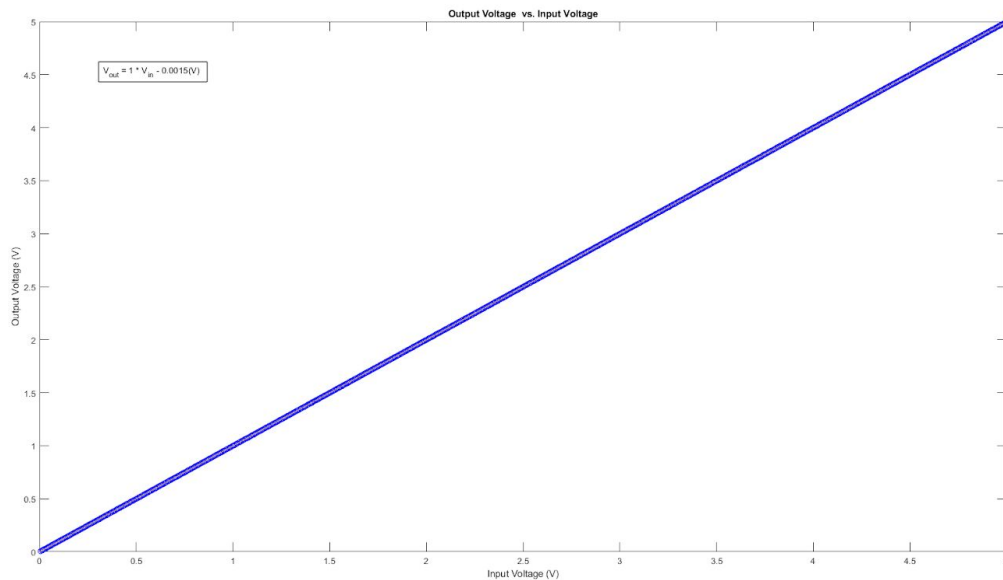

Figure 3. Response of buffer test circuit to input voltage sweep from 0 to 5 Volts. Curve fit yields

$$V_{out} = V_{in} + 0.0015V$$

Analyzing figures 3 and 4, The measured response of the op-amp buffer test circuit is slightly offset from the input voltage. This means that the gain is approximately 1, which is desired since the buffer circuit should not amplify or reduce the input voltage. Therefore, the op-amp buffer circuit is functional and it can be used to test the response of second order circuits.

B. Second-Order at 1k Ω resistance

Using the known values of the circuit components, we can calculate the properties of the filter implemented by the second-order circuit that can then be compared to the experimental values observed.

$$\begin{aligned}(1/LC) - \omega_c^2 &= 0 \\ \omega_c &= 1/\sqrt{LC} \\ f_c &= 1/(2\pi\sqrt{(0.00000022 * 0.0033)}) \approx 5906.794\text{Hz}\end{aligned}$$

Equation 1. Equation to find center frequency of the filter implemented by the second-order circuit.

The cutoff frequencies can be found where the response is -3dB. This happens when the real component of the denominator is equivalent to $\pm(R\omega)/L$.

$$1/(LC) - \omega^2 = \pm R/L$$

$$\omega = \pm(R/2L) + \sqrt{[(R/2L)^2 + (1/LC)]}$$

$$\omega_{c1, c2} = \pm(1000/0.0066) + \sqrt{[(1000/0.0066)^2 + (1/(0.0033 * 0.0000022))]} \approx 4479.245, 307509.547$$

$$f_{c1, c2} = 712.894\text{Hz}, 48941.665\text{Hz}$$

Equation 2. Equation to find cutoff frequencies of the filter implemented by the second-order circuit.

Using the cutoff frequency, the bandwidth and quality factor can be determined.

$$B = f_{c2} - f_{c1}$$

$$B = 48941.665 - 712.894 = 48228.771\text{Hz}$$

$$Q = f_c/B$$

$$Q = 5906.794 / 48228.771 \approx 0.122$$

Equation 3. Equation for finding the bandwidth and quality factor of the filter implemented by the second-order circuit.

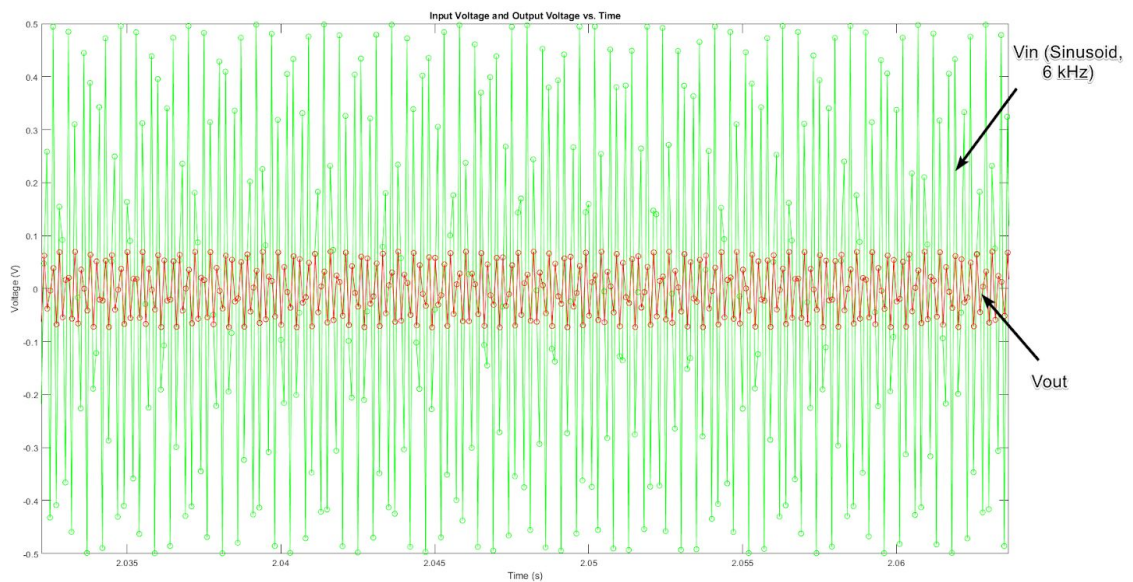

Figure 4. Graph of output voltage of the second-order circuit in response to an input sinusoid with a frequency near the center frequency.

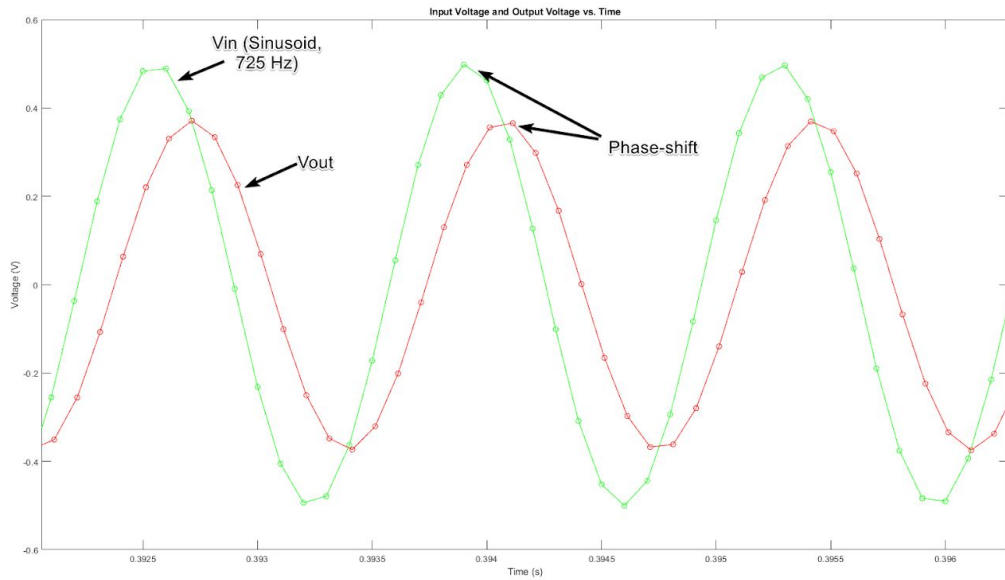

Figure 5. Graph of output voltage of the second-order circuit in response to an input sinusoid with a frequency significantly less than the first cutoff.

From figure 4, it can be observed that the circuit filters out input signals with a frequency near the center frequency. Note that in figure 5, where the frequency of the input comes before the first cutoff, the circuit passes the signal with only slight shifts to magnitude and phase.

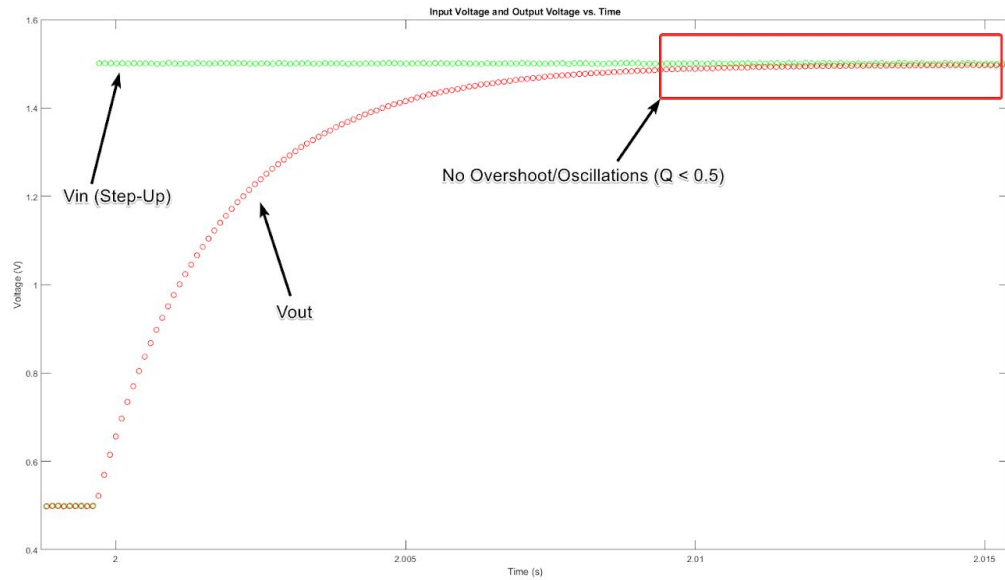

Figure 6. Response of second-order circuit with 1k Ω resistance to input voltage step up from 0.5 to 1.5 Volts

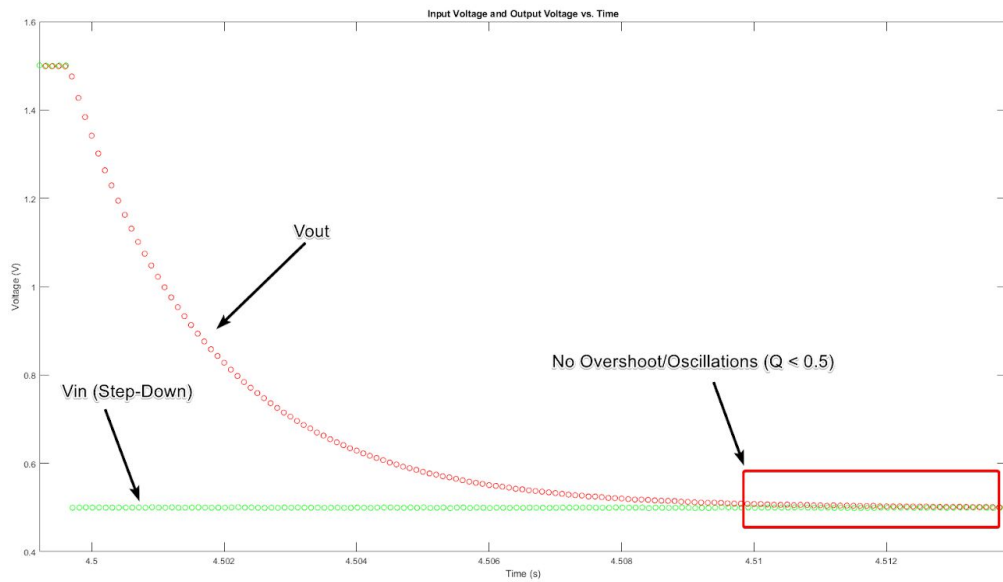

Figure 7. Response of second-order circuit with $1k\Omega$ resistance to input voltage step down from 1.5 to 0.5 Volts

The step responses seen in figures 4 and 5 have no overshoot, meaning that the roots of the second-order differential equation representing it are real.

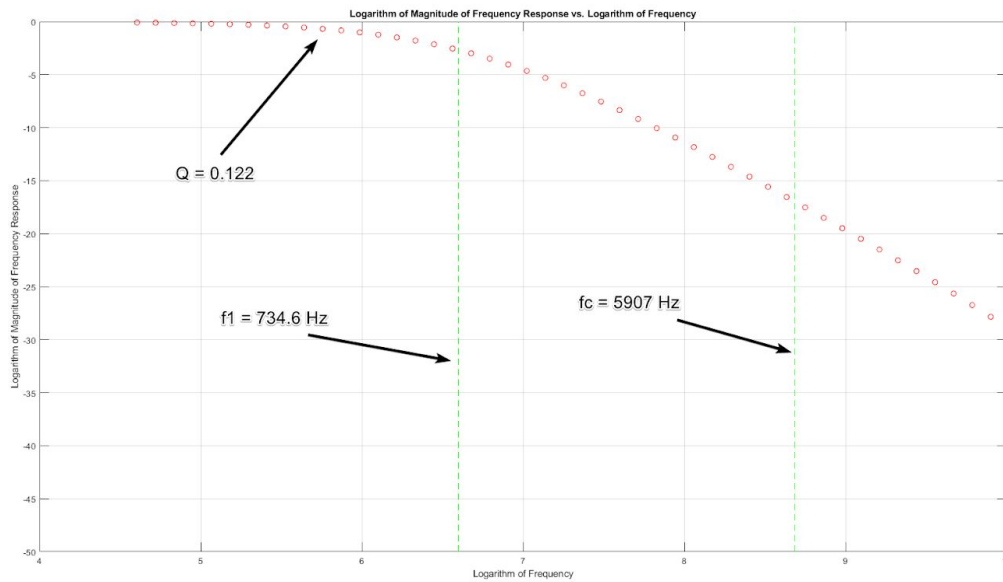

Figure 8. Magnitude of frequency response of the filter due to input frequency sweep. Observed quality factor, first cutoff, and center frequency are marked.

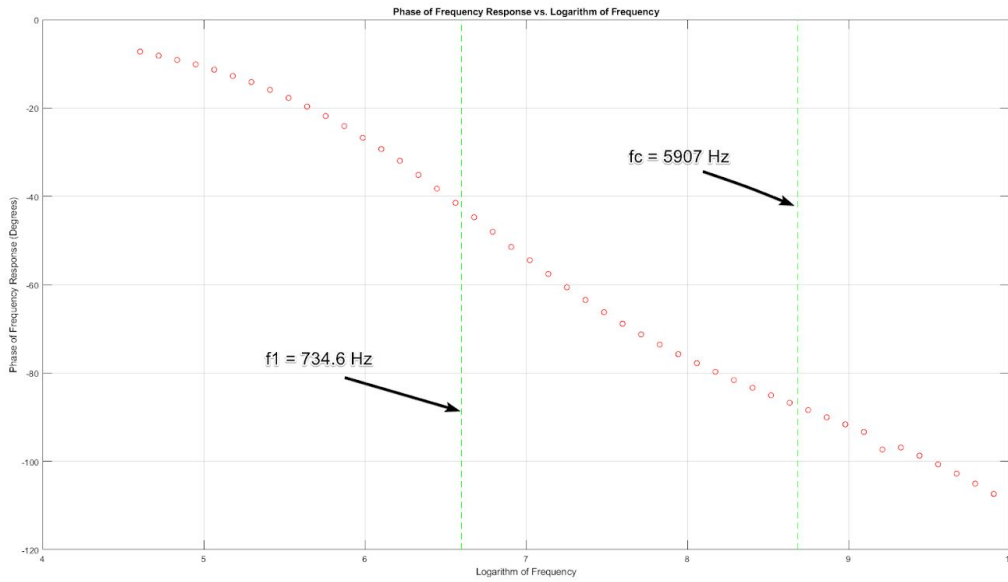

Figure 9. Phase of frequency response due to input frequency sweep. Observed center frequency and first cutoff are marked.

The center frequency, quality factor, and first cutoff observed are similar to the theoretical values calculated previously.

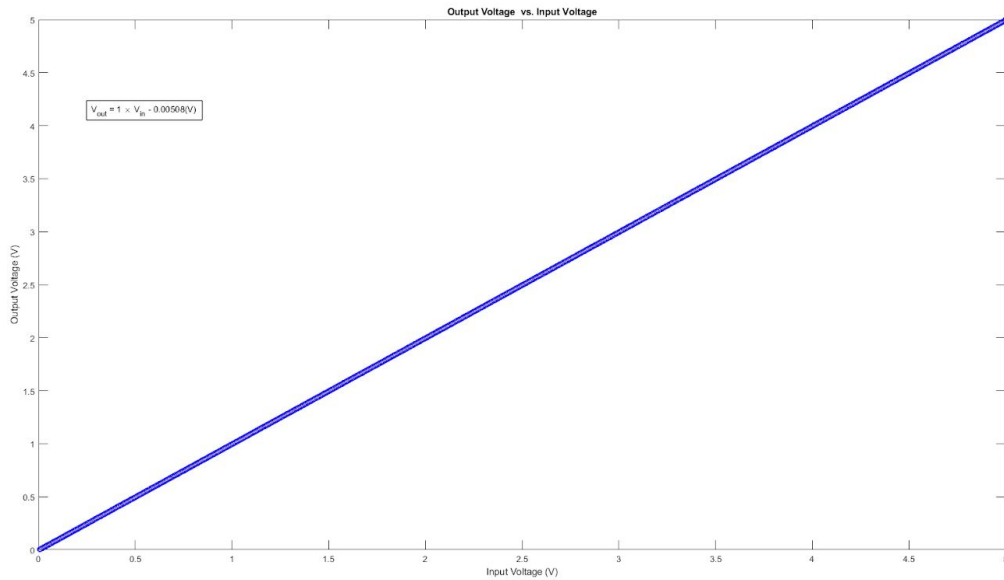

Figure 10. Response of second-order circuit to input sweep from 0V to 5V. Curve fit yields $V_{out} = V_{in} - 0.00508V$

The derived fit equation shows that the output of the circuit is very similar to the input as is described in the procedure.

C. Second-Order at 50Ω resistance

The second-order circuit in Figure 2 is tested again, but this time with the 1kΩ resistor replaced by a 50Ω resistor. Analyzing Equations 1,2, and 3, it can be predicted that the center frequency of the filter will remain the same, but the quality factor may change, as it is affected by the resistance. Equations 2 and 3 can be analyzed to produce a quicker formula for calculating the quality factor.

$$B = \omega_2 - \omega_1 = R/L$$

$$Q = \omega_c / B = (1 / \sqrt{LC}) / (R / L)$$

$$Q = 2.449$$

Equation 4. Calculation of the quality factor for the second-order circuit with a 50-ohm resistor

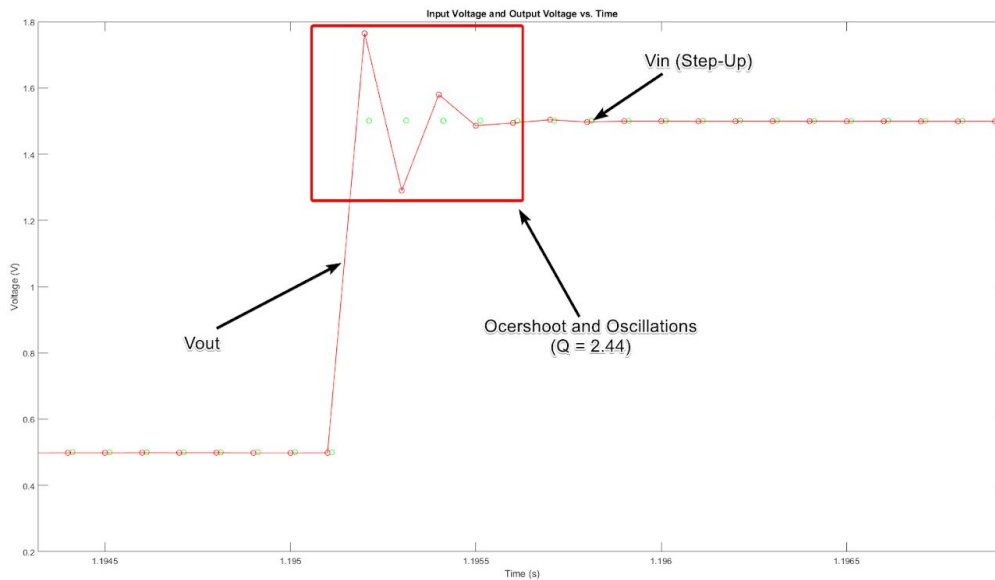

Figure 11. Response of second-order circuit with 50Ω resistance to input step from 0.5 up to 1.5 Volts.

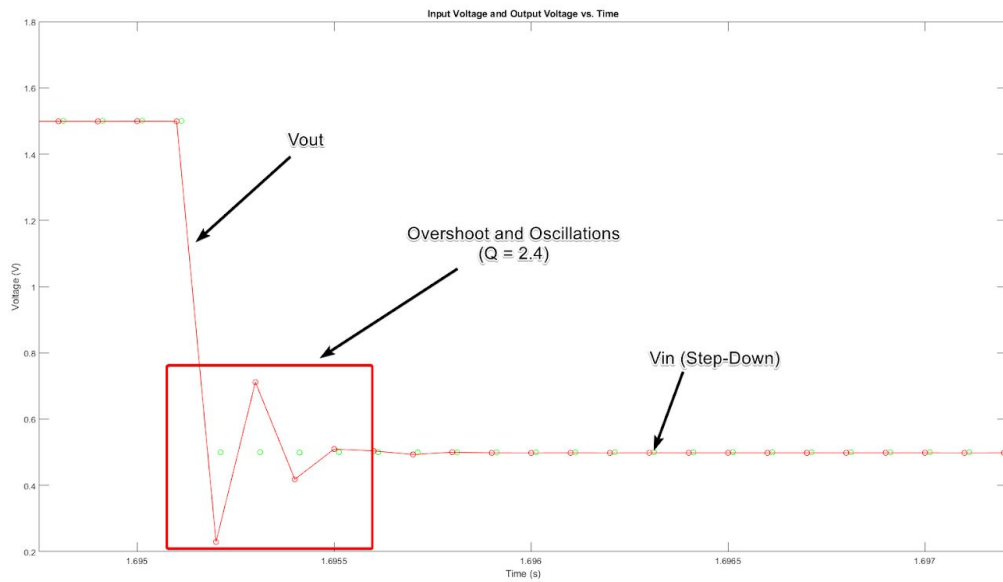

Figure 12. Response of second-order circuit with 50Ω resistance to input step from 1.5 down to 0.5 Volts.

Overshoot and oscillation can be observed in the response of the circuit. This means that the roots of the differential equation representing this second-order circuit are now complex due to the change in resistance.

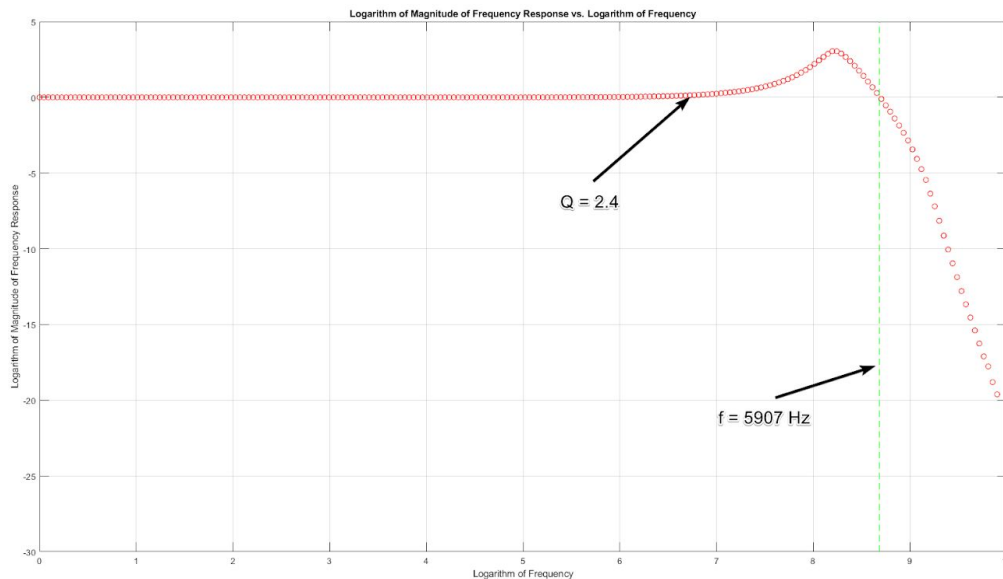

Figure 13. Magnitude of frequency response of the second-order circuit with 50Ω resistance due to input frequency sweep. Center frequency and quality factor are annotated.

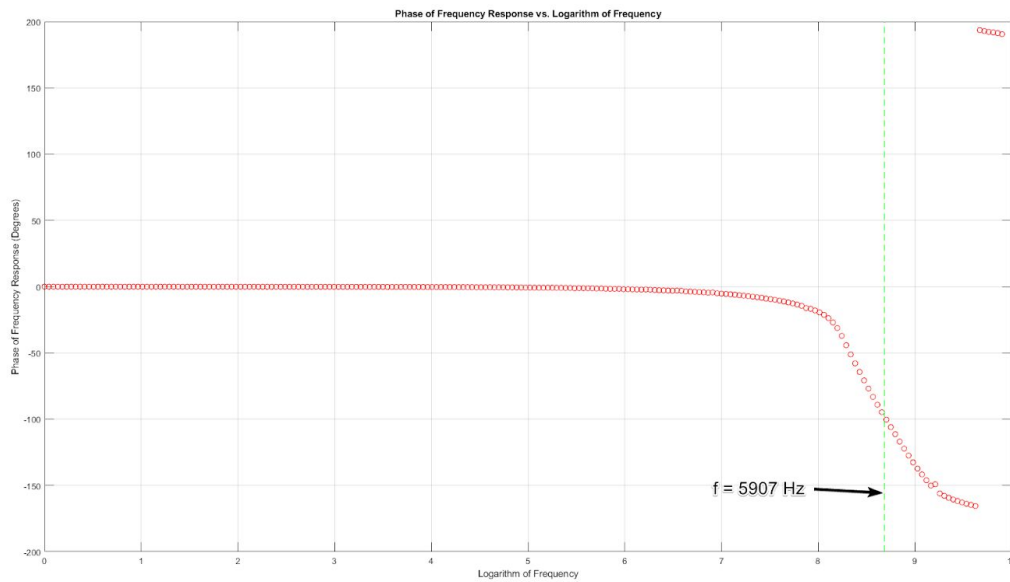

Figure 14. Phase of frequency response of the second-order circuit with 50Ω resistance due to input frequency sweep. Center frequency is annotated.

The figures confirm the expectation of a quality factor approximately equal to 2.449 and an unchanged center frequency.

D. Testing with Potentiometer

The resistor in the second-order circuit is now replaced with a potentiometer. This makes it easy to analyze how changes in resistance affect the response of the circuit. The circuit's response was observed once with the potentiometer at its minimum resistance of 0.113Ω , and once more at its max resistance of $4.68\text{ k}\Omega$. Based on the results of the prior two tests, the center frequency should not change, but the circuit with a higher resistance will have a smaller quality factor.

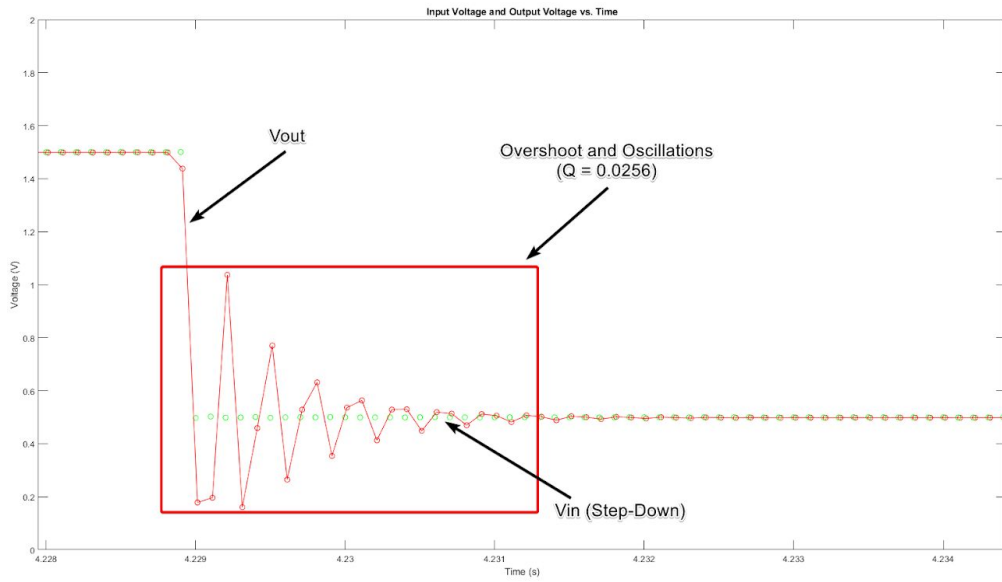

Figure 15. Response of second-order circuit with resistance of 0.113Ω to an input step down from 1.5 to 0.5 V.

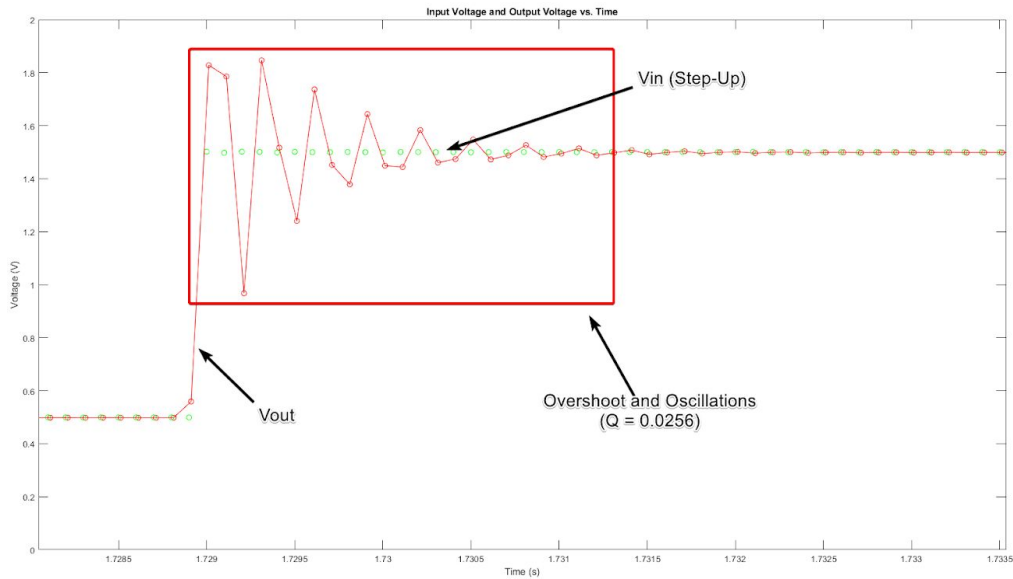

Figure 16. Response of second-order circuit with resistance of 0.113Ω to an input step up from 0.5 to 1.5 V.

The overshoot and oscillation seen in Figures 15 and 16 mean that the second-order equation with a resistance of 0.113Ω representing this circuit has complex roots.

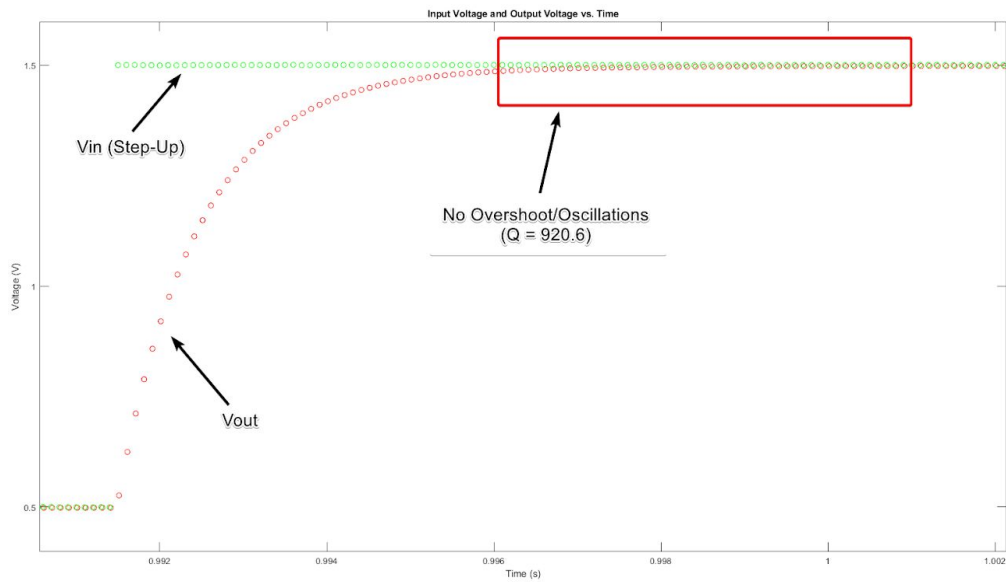

Figure 17. Response of second-order circuit with resistance of $4.78\text{k}\Omega$ to an input step up from 0.5 to 1.5 V.

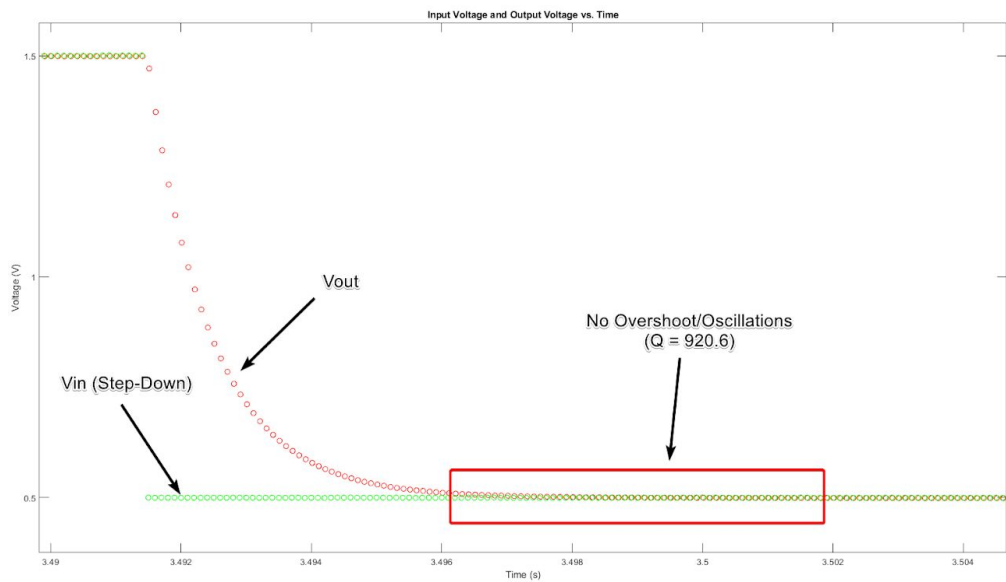

Figure 18. Response of second-order circuit with resistance of $4.78\text{k}\Omega$ to an input step down from 1.5 to 0.5 V.

In the second-order circuit with a resistance of $4.78\text{k}\Omega$, the graph of the response does not overshoot or oscillate. Therefore, the roots of the second-order differential equation representing this circuit are real.

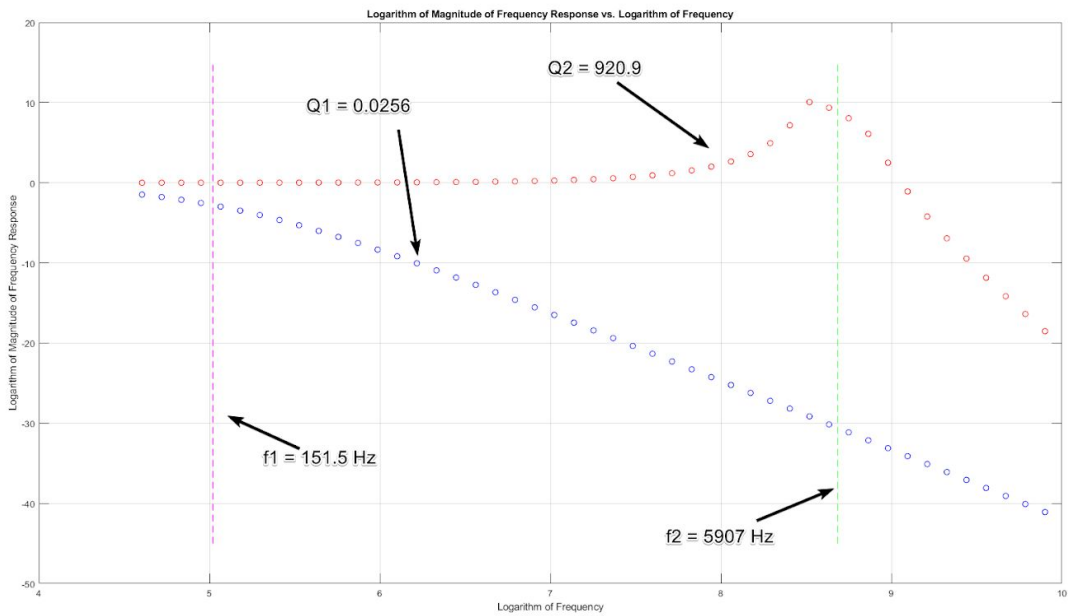

Figure 19. Magnitude of frequency response of the second-order circuit with a potentiometer due to frequency sweep input. Blue line represents potentiometer set to 4.78k Ω , and red represents setting of 0.113 Ω .

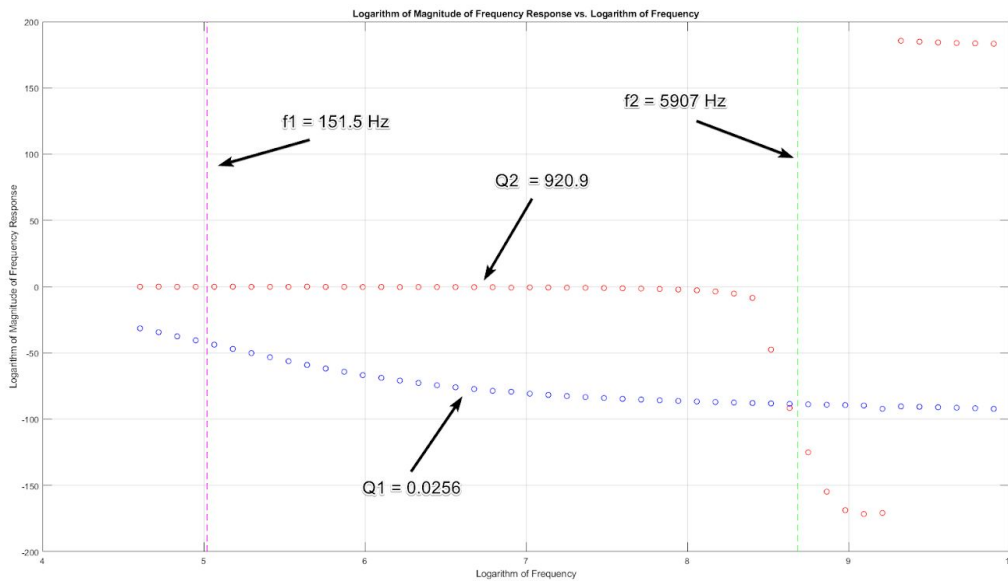

Figure 20. Phase of frequency response of the second-order circuit with a potentiometer due to frequency sweep input. Blue line represents potentiometer set to 4.78k Ω , and red represents setting of 0.113 Ω .

Figures 19 and 20 confirm expectations of how the response of a second-order circuit would change due to changes in resistance. Although the center frequency always stays unchanged, the quality factor is greater when resistance is lesser. Since the quality factor is the center frequency divided by the bandwidth, and the center frequency does not change, it can be observed that a lesser resistance leads to a smaller bandwidth.

III. Conclusion

The graphs of the magnitude of the frequency responses make it clear that this circuit is a low-pass filter. Input frequencies near or greater than the center frequency produce a very low gain, while input frequencies much lesser are passed mostly unchanged. This theoretically makes sense, as the output voltage is being measured across the capacitor in the second-order circuit. Capacitors essentially act as a delay to a periodic input, so if the frequency becomes too high the element will fail to accurately transfer the signal.

Observed data was generally in line with the calculated theoretical values, so it is clear that both calculation and experimental observation are a valid methods of analyzing practical second-order circuits. However, there were minor discrepancies between theoretical and observed values. A likely contributor to this is manufacturing tolerances. Real components are not ideal, and although the errors are small enough so as to not invalidate the results, they could have caused the small differences that were found. Interactions with the MyDAQ may have also lead to error, but this was likely mitigated by the op-amp buffer.